



ETA-Danmark A/S  
Göteborg Plads 1  
DK-2150 Nordhavn  
Tel. +45 72 24 59 00  
Internet [www.etadanmark.dk](http://www.etadanmark.dk)

Authorised and notified  
according to Article 29 of the  
Regulation (EU)  
No 305/2011 of the European  
Parliament and of the Council  
of 9 March 2011

MEMBER OF EOTA



## European Technical Assessment ETA-20/1131 of 2020/12/15

### I General Part

**Technical Assessment Body issuing the ETA and designated according to Article 29 of the Regulation (EU) No 305/2011: ETA-Danmark A/S**

**Trade name of the construction product:**

FIREPRO® High Expansion Intumescent Sealant

**Product family to which the above construction product belongs:**

Fire Stopping, Fire Sealing & Fire Protective Products.  
Fire Retardant Products

**Manufacturer:**

ROCKWOOL Ltd  
Pencoed  
Bridgend  
South Wales  
CF35 6NY

**Manufacturing plant:**

E/089

**This European Technical Assessment contains:**

21 pages including 3 annexes which form an integral part of the document

**This European Technical Assessment is issued in accordance with Regulation (EU) No 305/2011, on the basis of:**

EAD 350454-00-1104 – Firestopping and fire sealing products – Penetration Seals: Issue September 2017

**This version replaces:**

-

**Translations of this European Technical Assessment in other languages shall fully correspond to the original issued document and should be identified as such.**

**Communication of this European Technical Assessment, including transmission by electronic means, shall be in full [except the confidential Annex(es) referred to above]. However, partial reproduction may be made with the written consent of the issuing Technical Assessment Body. Any partial reproduction has to be identified as such.**

## **1 Technical Description of the Product**

- 1) FIREPRO® High Expansion Intumescent Sealant is an acrylic based graphite sealant used to reinstate the fire resistance performance of wall and floor constructions where they have been provided with apertures for the penetration of single or multiple services.
- 2) FIREPRO® High Expansion Intumescent Sealant is gun applied to annular space around the service(s) to the required depth (for details see Annex C)
- 3) FIREPRO® High Expansion Intumescent Sealant is supplied in 330ml cartridges or 2.5kg, 5kg, 10kg pails.

## 2 Specification Of The Intended Use In Accordance With The Applicable European Assessment Document (EAD)

The intended use of FIREPRO® High Expansion Intumescent Sealant is to reinstate the fire resistance performance of rigid and flexible walls and rigid floor constructions where they are penetrated by various cables, cable trays and plastic and insulated metallic pipes

- 1) The specific elements of construction that the system FIREPRO® High Expansion Intumescent Sealant may be used to provide a penetration seal in, are as follows:

Rigid walls: The wall must have a minimum thickness of 100 mm and comprise concrete, aerated concrete or masonry, with a minimum density of 650 kg/m<sup>3</sup>.

Rigid walls: The wall must have a minimum thickness of 120 mm and comprise concrete, aerated concrete or masonry, with a minimum density of 650 kg/m<sup>3</sup>.

Rigid floors: The floor must have a minimum thickness of 150 mm and comprise concrete, aerated concrete or masonry, with a minimum density of 650 kg/m<sup>3</sup>.

Flexible walls The wall must have a minimum thickness of 100 mm and comprise timber or steel studs lined on both faces with minimum 2 layers of 12.5 mm thick, 'Type F' Gypsum boards according to EN 520. In timber stud walls, no part of the penetration shall be closer than 100 mm to a stud, the cavity must be closed between the penetration seal and the stud and minimum 100 mm of insulation of class A1 or A2 according to EN 13501-1, is provided within the cavity between the penetration seal and the stud.

Flexible walls The wall must have a minimum thickness of 120 mm and comprise timber or steel studs lined on both faces with minimum 2 layers of 15 mm thick, 'Type F' Gypsum boards according to EN 520. In timber stud walls, no part of the penetration shall be closer than 100 mm to a stud, the cavity must be closed between the penetration seal and the stud and minimum 100 mm of insulation of class A1 or A2 according to EN 13501-1, is provided within the cavity between the penetration seal and the stud.

The supporting construction must be classified in accordance with EN 13501-2 for the required fire resistance period.

- 2) The FIREPRO® High Expansion Intumescent Sealant may be used to provide a penetration seal with plastic and insulated metallic pipes, and cables and cable trays (for details see Annex C).
- 3) The total amount of cross sections of services (including insulation) should not exceed 60% of the penetration area.
- 4) The FIREPRO® High Expansion Intumescent Sealant may be used to seal apertures in the wall separating element up to 100mm wide by 300mm high. The FIREPRO® High Expansion Intumescent Sealant may be used to seal apertures in the floor separating element up to 250mm wide by 250mm high. The minimum permitted separation between adjacent seals/apertures is 200mm.
- 5) Pipes must be installed singular, cables require no minimum separation.
- 6) Services in walls and floors shall be supported at the distances specified in Annex C from the face of the separating element.
- 7) The provisions made in this European Technical Assessment are based on an assumed working

life of the FIREPRO® High Expansion Intumescent Sealant of 10 years, provided that the conditions laid down in the product data sheet for the packaging/transport/storage/installation/use/repair are met. The indications given on the working life cannot be interpreted as a guarantee given by the producer or the Technical Assessment Body, but are to be regarded only as a means for choosing the right products in relation to the expected economically reasonable working life of the works.

## **2.1 Use Category**

Type Z<sub>1</sub>: Intended for use in internal conditions with humidity equal to or higher than 85% RH excluding temperatures below 0°C, without exposure to rain or UV.

### 3 Performance of The Product And References To The Methods Used For Its Assessment

	<b>2</b>	<b>Safety in case of fire</b>	
		Reaction to fire	No performance assessed
		Resistance to fire	See clause 1.2
	<b>3</b>	<b>Hygiene, Health and the Environment</b>	
		Air permeability	See clause 2.1
		Content and release of dangerous substances	See clause 2.2
	<b>4</b>	<b>Safety and accessibility in use</b>	
		Durability and serviceability	See clause 3.1
	<b>5</b>	<b>Protection against noise</b>	
		Airborne sound insulation	See clause 4.1

#### 3.1 Safety in case of fire

##### 3.1.1 Reaction to fire

No performance assessed.

##### 3.1.2 Resistance to fire

FIREPRO® High Expansion Intumescent Sealant has been tested in accordance with BS EN 1366-3: 2009 based upon the test results and the field of direct application specified within EN 1366-3: 2009, the FIREPRO® High Expansion Intumescent Sealant has been classified in accordance with EN 13501-2, as given in Annex C:

The seals may only be penetrated by the services described in Annex C; other parts or support constructions must not penetrate the seal.

The service support construction must be fixed to the building element containing the penetration seal or a suitable adjacent building element, in such a manner that in the case of fire, no additional load is imposed on the seal. Furthermore it is assumed that the unexposed face support is maintained for the required period of fire resistance.

Pipes must be perpendicular to the seal surface.

It is assumed that compressed air systems are switched off by other means in the case of fire.

The function of the pipe seal in case of pneumatic dispatch systems, pressurised air systems etc. is guaranteed only when the systems are shut off in case of fire. The assessment does not cover the avoidance of destruction of the seal or of the abutting building element(s) by forces caused by temperature changes in case of fire. This has to be considered when designing the piping system.

The assessment does not address any risks associated with leakage of dangerous liquids or gases caused by failure of the pipe(s) in case of fire.

The durability assessment does not take account of the possible effect of substances permeating through the pipe on the penetration seal.

## 3.2 Hygiene, Health and the Environment

### 3.2.1 Air permeability

FIREPRO® High Expansion Intumescent Sealant has been tested in accordance with BS EN 1314-1 to provide the following results:

Product tested		Pyropro HPE sealant		
Pressure (Pa)	Results under positive chamber pressure		Results under negative chamber pressure	
	Leakage (m <sup>3</sup> /h)	Leakage (m <sup>3</sup> /m <sup>2</sup> /h)	Leakage (m <sup>3</sup> /h)	Leakage (m <sup>3</sup> /m <sup>2</sup> /h)
50	0.2	5.6	0.3	8.3
100	0.4	11.1	0.6	16.7
150	0.7	19.4	0.9	25.0
200	1.0	27.8	1.2	33.3
250	1.1	30.6	1.6	44.4
300	1.2	33.3	1.9	52.8
450	2.2	61.1	2.7	75.0
600	2.4	66.7	3.4	94.4

### 3.2.2 Content and release of Dangerous substances

Rockwool Ltd has presented a declaration that FIREPRO® High Expansion Intumescent Sealant does not contain any substance of high concern with regards to REACH Regulations and are compliant with the requirements reference to <http://ec.europa.eu/enterprise/construction/cpd-ds/index.cfm>

Confirmation has further been declared that all dangerous chemical substances  $\geq 1.0$  % w/w as well as all toxic, carcinogenic, toxic for reproduction and mutagenic chemical substances  $\geq 0.1$  % w/w (Status: 29. adaption – 2004/73/EG – of the EU directive 67/548/EEC - classification, packaging and labelling of dangerous substances) are stated in the FIREPRO® High Expansion Intumescent Sealant safety data sheets (according to 91/155/EEC including amendments) and have been considered for the classification of the products according to the directive 1999/45/EG (classification of preparations, including amendments).

All dangerous chemical substances are below the classification limits of 67/548/EEC.

In addition to the specific clauses relating to dangerous substances contained in this European technical approval, there may be other requirements applicable to the products falling within its scope (e.g. transposed European legislation and national laws, regulations and administrative provisions). In order to meet the provisions of the Construction Products Regulation, these requirements need also to be complied with, when and where they apply.

## 3.3 Safety and Accessibility in use.

### 3.3.1 Durability

FIREPRO® High Expansion Intumescent Sealant has been tested in accordance with EOTA Technical Report - TR024 – EAD 350454-00-1104 – Firestopping and fire sealing products – Penetration Seals , for the type Z1, and the results of the tests have demonstrated suitability for penetration seals intended for use in internal conditions with humidity equal to or higher than 85% RH excluding temperatures below 0°C, without exposure to rain or UV.

## **3.4 Protection against noise**

### 3.4.1 Airborne Sound Insulation

The results of the test provided the following single number rating

$R_w(C;Ctr)=52(-1;-6)$



#### **4 Assessment and Verification Of Constancy Of Performance (Hereinafter AVCP) System Applied, With References To Its Legal base**

According to the decision 1999/454/EC of the European Commission the system of assessment and verification of constancy of performance (see Annex V to the Regulation (EU) No 305/2011) given in the following table apply:

<b>Products</b>	<b>Intended use(s)</b>	<b>AVCP System</b>
Fire stopping and fire sealing products	For fire compartmentation and / or fire protection or fire performance	System 1

#### **5 Technical details necessary for the implementation of the AVCP system, as provided for in the applicable EAD**

Technical details necessary for the implementation of the AVCP system are laid down in the control plan deposited at ETA-Danmark A/S prior to CE marking

Issued in Copenhagen on 2020-12-15 by



Thomas Bruun  
Managing Director, ETA-Danmark

## **Annex A**

### **Reference Documents**

EN 13501-1	Fire classification of construction products and building elements – Part 1: Classification using test data from reaction to fire tests
EN 13501-2	Fire classification of construction products and building elements – Part 2: Classification using test data from fire resistance tests
EOTA TR 024	Characterisation, Aspects of Durability and Factory Production Control for Reactive Materials, Components and Products

## **Annex B**

### **Description of Product**

#### **FIREPRO® High Expansion Intumescent Sealant**

A detailed specification of the product is contained in document "Evaluation Report" relating to the European Technical Assessment ETA – 15/0325 issued 08/04/15, of FIREPRO® High Expansion Intumescent Sealant which is a non-public part of this ETA.

## Annex C

### Resistance to Fire Classification of FIREPRO® High Expansion Intumescent Sealant

#### C1.1 Flexible and Rigid wall constructions according to 1.2.1 with wall thickness of minimum 120 mm

##### C.1.1.1 Penetration seal with FIREPRO® High Expansion Intumescent Sealant – Plastic Pipes

###### Construction details:

- FIREPRO® High Expansion Intumescent Sealant applied into the annular space to the required depth as per table
- First support positioned 150mm from both faces of the substrate

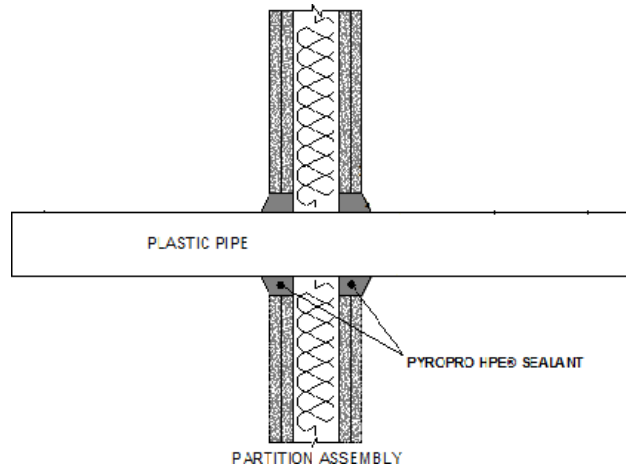

Penetration Specification	FIREPRO® High Expansion Intumescent Sealant (installed both faces)	Backing Material	Classification
PVC Pipe 40mm ø 1.9-3mm wall thickness	10mm annulus x 25mm deep	N/A	EI120 U/C
PVC Pipe 125mm ø 4.8-7.4mm wall thickness	16mm annulus x 25mm deep	30mm deep, 80Kg/m <sup>3</sup>	EI120 U/C
HDPE Pipe 63mm ø 7.2mm wall thickness, Cables up to 21mm ø	300mm wide x 100mm high x 25mm deep	N/A	EI120 U/C
HDPE Pipe 90mm ø 9.2mm wall thickness,	12.5mm annulus x 25mm deep	N/A	EI120 U/C
ABS Pipe 90mm ø 6mm wall thickness,	12.5mm annulus x 25mm deep	N/A	EI120 U/C

**C2.1 Flexible and Rigid wall constructions according to 1.2.1 with wall thickness of minimum 120 mm**

**C.2.2 Penetration seal with FIREPRO® High Expansion Intumescent Sealant – Insulated Metallic Pipes**

- FIREPRO® High Expansion Intumescent Sealant FS705 Intumescent Sealant applied into the annular space to the required depth as per table C2.3

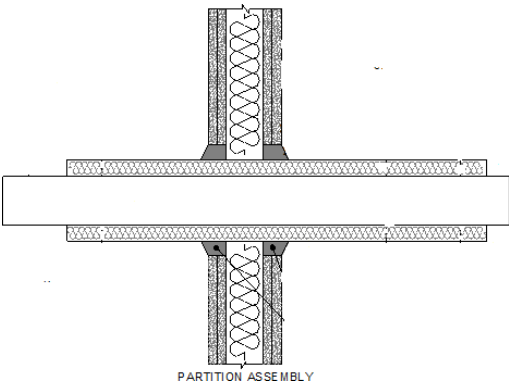

**C.2.3**

Penetration Specification	FIREPRO® High Expansion Intumescent Sealant (installed both faces)	Backing Material	Classification
Copper/Steel Pipe 60mm ø 0.8mm -14.2mm wall thickness, insulated with 32mm 'Armaflex AF' (CS) Continued Sustained	20mm annulus x 25mm deep	N/A	E120 U/C EI90 U/C
Copper/Steel Pipe 15mm ø 0.8mm -7mm wall thickness, insulated with 13mm 'Armaflex AF' (CS) Continued Sustained	15mm annulus x 25mm deep	N/A	EI120 U/C

**C3.1 Flexible and Rigid wall constructions according to 1.2.1 with wall thickness of minimum 100 mm**

**C3.2 Penetration seal with FIREPRO® High Expansion Intumescent Sealant – Plastic Pipes**

**Construction details:**

- FIREPRO® High Expansion Intumescent Sealant applied into the annular space to the required depth as per table C3.3

**C3.3**

Penetration Specification	FIREPRO® High Expansion Intumescent Sealant (installed both faces)	Backing Material	Classification
PVC Pipe 40mm ø 1.9mm wall thickness	20mm annulus x 25mm deep	N/A	<b>EI120 C/U</b>
PVC Pipe 125mm ø 9.2mm wall thickness	20mm annulus x 25mm deep	N/A	<b>EI60 C/U</b>
ABS Pipe 40mm ø 1.9mm wall thickness	20mm annulus x 25mm deep	N/A	<b>EI120 C/U</b>
HDPP Pipe 40mmø 2mm wall thickness	20mm annulus x 25mm deep	N/A	<b>EI120 C/U</b>

### C4.1 Flexible and Rigid wall constructions according to 1.2.1 with wall thickness of minimum 100 mm

### C4.2 Penetration seal with FIREPRO® High Expansion Intumescent Sealant – Insulated Metallic Pipes

#### Construction details:

- FIREPRO® High Expansion Intumescent Sealant applied into the annular space to the required depth as per table C4.3

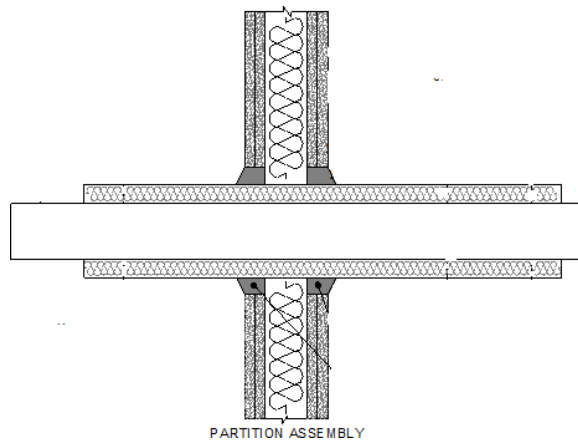

### C4.3

Penetration Specification	FIREPRO® High Expansion Intumescent Sealant (installed both faces)	Backing Material	Classification
Copper/Steel Pipe 40mm ø 1.5mm – 14.2mm wall thickness insulated with 32mm 'Armaflex AF' (LS 650mm) Local Sustained 650mm	20mm annulus x 25mm deep	N/A	<b>E120 C/U</b> <b>EI30 C/U</b>
Copper/Steel Pipe 40mm - 159mm ø 2.0 mm – 14.2mm wall thickness insulated with 32mm 'Armaflex AF' (LS 650mm) Local Sustained 650mm	20mm annulus x 25mm deep	N/A	<b>E120 C/U</b> <b>EI30 C/U</b>
Copper/Steel Pipe 159mm ø 2.0 mm – 14.2mm wall thickness insulated with 30mm x 80kg/m³ 'Pipelane' SGR glass wool tube (LS 650mm) Local Sustained 650mm	20mm annulus x 25mm deep	N/A	<b>E120 C/U</b> <b>EI30 C/U</b>

### C5.1 Rigid floor constructions according to 1.2.1 with floor thickness of minimum 150 mm

### C5.2 Penetration seal with FIREPRO® High Expansion Intumescent Sealant – Electrical cables

#### Construction details:

- FIREPRO® High Expansion Intumescent Sealant applied into the annular space to the required depth as per table C5.3

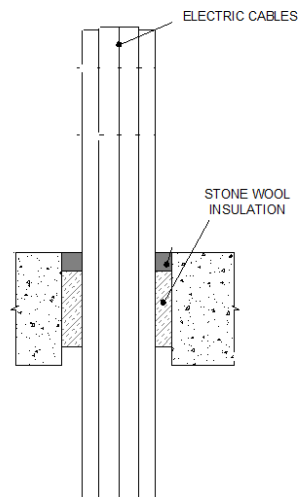

### C5.3

Penetration Specification	FIREPRO® High Expansion Intumescent Sealant (installed upper face only)	Aperture Size (mm)	Backing Material	Classification
Electrical Cables 0-21mm $\varnothing$	25mm deep	Max 200 x 200 Min 50 x 50	100mm Deep stone wool 45 kg/m <sup>3</sup>	<b>E180</b> <b>EI20</b>
Electrical Cables 22-80mm $\varnothing$				<b>E120</b> <b>EI20</b>
Non sheathed electrical cables 0-24mm $\varnothing$				<b>E180</b> <b>EI15</b>
Up to 21mm $\varnothing$ telecomm cables in bundles of up to 100 mm diameter				<b>E180</b> <b>EI20</b>



**C6.1 Rigid floor constructions according to 1.2.1 with floor thickness of minimum 150 mm**

**C6.2 Penetration seal with FIREPRO® High Expansion Intumescent Sealant – Insulated Metallic Pipes**

**Construction details:**

- FIREPRO® High Expansion Intumescent Sealant applied into the annular space to the required depth as per table C6.3

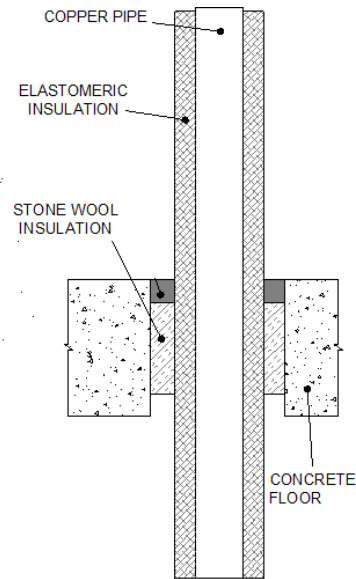

**C6.3**

Penetration Specification	FIREPRO® High Expansion Intumescent Sealant (installed upper face only)	Aperture Size (mm)	Backing Material	Classification
Copper/Steel Pipe 41mm – 159mm ø 2.5mm -14.2mm wall thickness, insulated with 16mm - 32mm 'Armaflex' (CS) Continued Sustained	25mm deep	20mm annulus	100mm Deep stone wool 45 kg/m <sup>3</sup>	<b>EI20 U/C</b>

### **C7.1 Rigid floor constructions according to 1.2.1 with floor thickness of minimum 150 mm**

### **C7.2 Penetration seal with FIREPRO® High Expansion Intumescent Sealant – Plastic Pipes**

#### **Construction details:**

- FIREPRO® High Expansion Intumescent Sealant applied into the annular space to the required depth as per table C 7.3-C 7.5

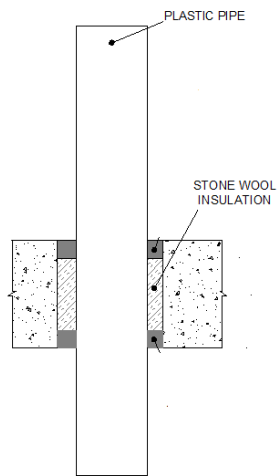

### 7.3

Penetration Specification	FIREPRO® High Expansion Intumescent Sealant (installed both faces)	Aperture Size (mm)	Backing Material	Classification
PP Pipe 110mm ø 3.7mm wall thickness	25mm deep	20mm annulus	100mm Deep stone wool 45 kg/m <sup>3</sup>	<b>EI30 U/C</b>
PP Pipe 110mm ø 10.7mm wall thickness				<b>EI120 U/C</b>
PP Pipe 50mm ø 2.1mm wall thickness				<b>EI240 U/C</b>

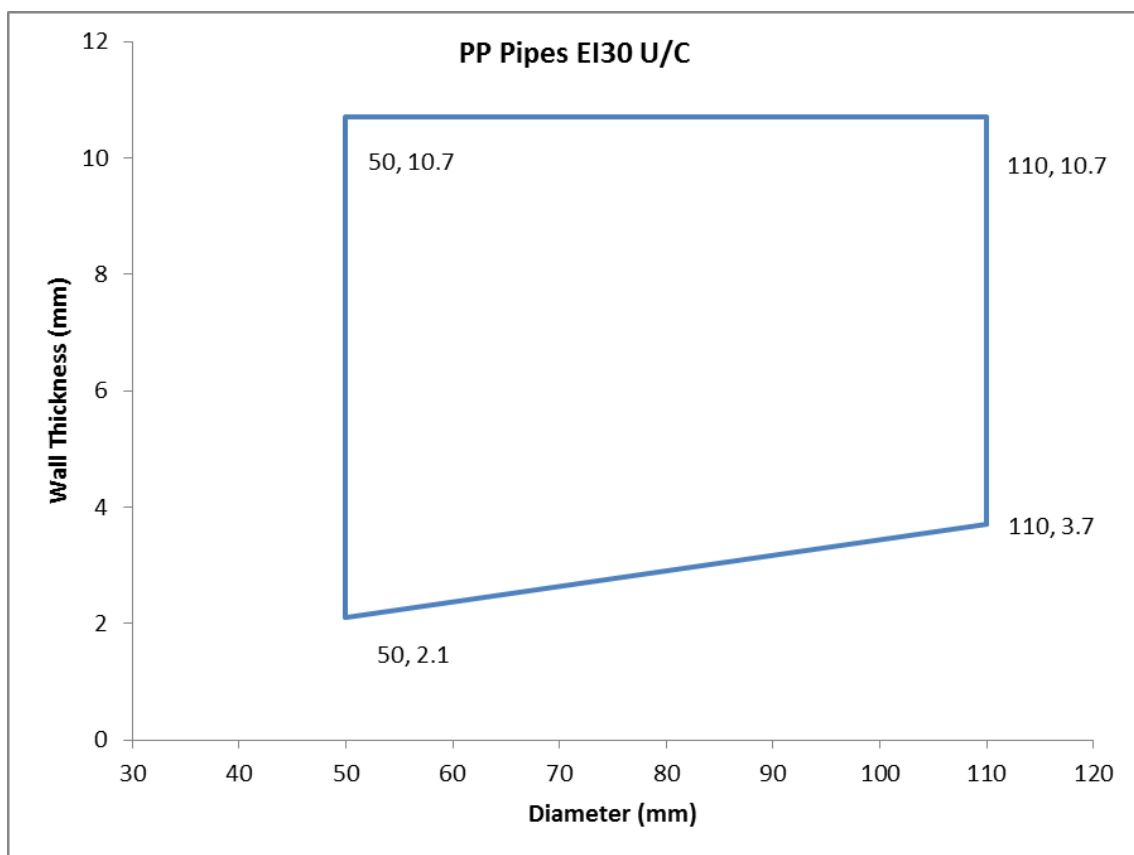

### 7.4

Penetration Specification	FIREPRO® High Expansion Intumescent Sealant (installed both faces)	Aperture Size (mm)	Backing Material	Classification
PE Pipe 40mm ø 4.1mm wall thickness	25mm deep	20mm annulus	100mm Deep stone wool 45 kg/m <sup>3</sup>	<b>EI240 U/C</b>
PE Pipe 125mm ø 7.6 mm wall thickness				<b>EI60 U/C</b>
PE Pipe 125mm ø 11.4 mm wall thickness				<b>EI90 U/C</b>

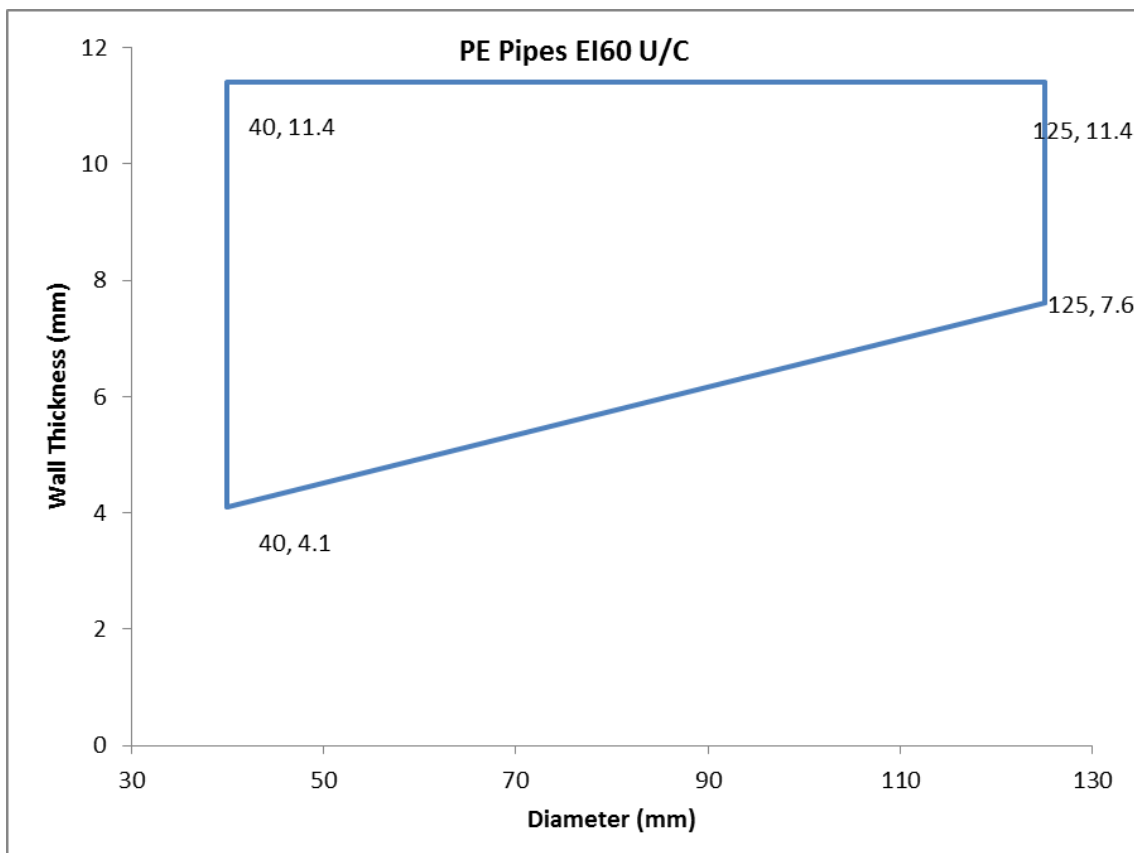

### 7.5

Penetration Specification	FIREPRO® High Expansion Intumescent Sealant (installed both faces)	Aperture Size (mm)	Backing Material	Classification
PVC Pipe 40mm ø 2mm wall thickness	25mm deep	20mm annulus	100mm Deep stone wool 45 kg/m <sup>3</sup>	<b>EI240 U/C</b>
PVC Pipe 114mm ø 3.6 mm wall thickness				<b>E90 U/C</b> <b>EI45 U/C</b>
PVC Pipe 114mm ø 8.1 mm wall thickness				<b>EI120 U/C</b>

